



SATR DATA SHEET: BATTLE BOX

© Battlefield Sports 2019

Contents



Data Sheet Introduction.....	3
Patented Laser Tag Equipment.....	3
Trademarks	3
Learning the Parts of Your Laser Tag Equipment.....	3
Parts of the Laser Tag Unit.....	Error! Bookmark not defined.
SATR Digital Radio Transceiver	4
SATR Micro-Processor.....	4
SATR Infrared Emitter	4
SATR Audio.....	5
SATR Battery	6
Compliance Testing.....	6
Warranty Terms	6
Disclaimer.....	8

Data Sheet Introduction

This Data Sheet covers the specification for the Battle Box Model.

BATTLE BOX / MEDIC / AMMO

RECOMMENDED : WE RECOMMEND MIN. 2 BATTLE BOXES PER FIELD





SPECIFICATION

WEIGHT
1.9 KG / 4 LBS

MAIN PURPOSE
THE BATTLE BOX'S MAIN PURPOSE IS TO LET THE GAMERS RESPAWN THEMSELVES

STANDARD ISSUE COLOR
GRAY



- 1. PATENTED TECHNOLOGY: REAL-TIME HIT FEEDBACK**
So you know when you've got them! Play any game, in any terrain. No need for a central computer. Worldwide licence free radio signal on 433 Mhz band.
- 2. AWESOME SOUND EFFECTS**
More than 11,000 SFX including in-game announcements. Choose from 21 Languages - a custom slot.
- 3. SIMPLE TO OPERATE**
Lock Out Mode - Set & Forget! While SATR can offer a diverse range of settings, sometimes you just want SIMPLE
- 4. FRIENDLY FIRE ON OR OFF**
Perfect for indoor game-play, players on the same team never have to worry about shooting their teammates.
- 5. NO CENTRAL COMPUTER SYSTEM**
100% Portable. Built in redundancy - boot any unit to act as any other, & you can boot up a gaming gun to act as a Master Controller.
- 5. REAL-TIME STATISTICS**
Each gamer can track how they are doing, from % accuracy, Hit Points, Ammo, to Kill/Death ratio, & more.
- 7. STANDARD INCLUSIONS**
All models have digital radio feedback and integrated sensors. The battery is long lasting & there's no need to remove it to re-charge.
- 8. SET GAMERS WIRELESSLY**
Easy to use Master Controller for fast, wireless game set-up - change game time, volume, set continuous play, plus many more options! Great for large groups needing high throughput.
- 9. HIGHLY CONFIGURABLE**
285 Emulations for a huge range of live gaming options. From Modern Militim and Tank battles to Fantasy Spell Casting and Monsters/Zombies, even support for American Civil War scenarios.
- 10. HUNDREDS OF LIVE GAME SCENARIOS**
Including popular games like Electronic Capture the Flag, Rush, Heist, Domination, and Free for All.
- 11. SET UP THE SYSTEM THE WAY YOU WANT**
Pre-sets up to 8 weapon slots. Switch between emulations such as your primary weapon, secondary weapon, and medical supplies.
- 12. TURN-KEY SYSTEM**
Only the operator can turn the unit on/off. One key fits all models. The unit stores previous configurations for quick set-up. Plus save up to 12 user-defined templates.
- 13. BUILT TOUGH**
Quality aluminium & steel construction or robust fiber-reinforced polycarbonate construction.
- 14. ALL WEATHER GAMING**
Marine Quality Mylar speakers for all weather gaming. Weather resistant enclosures work fine in showers and light rain.
- 15. CONFIGURABLE DIFFICULTY LEVEL**
Easy / Standard / Hard / Legendary. Customize your customer's experience for any age-group or skill level.
- 16. SELF-DIAGNOSTICS**
Straight-forward to maintain. Compliance testing from an independent Test Laboratory.
- 17. OPERATOR SUPPORT**
Battlefield Sports University, Portal Listing and more.
- 18. ALL NEW GAME-PLAY SUPPORT**
Amp up the Game-Play with perk and mystery boxes. Offering gamers new in-game perks like "super mag" or "stopping power"
- 19. THE BEST GAMER EXPERIENCE**
Battlefield Sports' SATR3 is hi-tech, customer & operator friendly, and easily customizable. It's the most versatile live gaming system on the market!

Patented Laser Tag Equipment

The Battlefield Sports laser tag equipment is protected by the following patents:

- US - 8,282,486
- AU - 2007335257
- EU & UK - 2126508

Trademarks

The following trademarks are applicable:

- Battlefield Sports
- SATR
- Battlefield LIVE
- Laser Skirmish: Ready, Aim... Fun!
- Laser Tag: Ready, Aim... Fun!

Learning the Parts of Your Laser Tag Equipment

Please note that the laser tag equipment does not shoot any projectiles. Rather the unit only emits harmless infrared light and issues low-level digital radio signals.

SATR Digital Radio Transceiver

SATR stands for Small Arms Transmitter Receiver. SATR uses a low-power sub-1 GHz RF transceiver to power its units. The smart RF transceiver operates on the 433 MHz band.

The RF transceiver is integrated with a highly configurable baseband modem. The modem supports various modulation formats. The transceiver provides hardware support for packet handling, data buffering, burst transmissions, clear channel assessment, link quality indication and wake-on-radio. This component is RoHS compliant and contains no antimony or bromine.

The RF Performance has high sensitivity:

- -116 dBm at 0.6 kBaud, 433 MHz, 1% packet error rate
- -112 dBm at 1.2 kBaud, 868 MHz, 1% packet error rate
- Low current consumption (14.7 mA in RX, 1.2 kBaud, 868 MHz)
- Programmable output power up to +12 dBm for all supported frequencies
- Excellent receiver selectivity and blocking performance
- Programmable data rate from 0.6 to 600 kbps
- Frequency band: 433 MHz

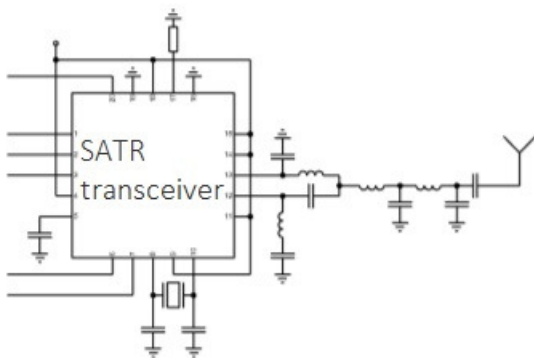

SATR Micro-Processor

SATR's digital engine is a micro-controller, a digital signal controller which migrates with the dsPIC33. It is a high-performance CPU with sixteen 16-bit general purpose registers.

SATR Infrared Emitter

The SATR system has a high-powered infrared emitting diode to emit infrared pulses. The component is a 940 nm emitting diode in GaAlAs multi quantum well (MQW) technology with high radiant power and high speed molded in a blue-gray plastic package. It offers relative radiant versus intensity angular displacement. The illustration below shows that the light

beam is not coherent, rather it is dispersed. Rather the beam's angle of half intensity is plus or minus 10 degrees.

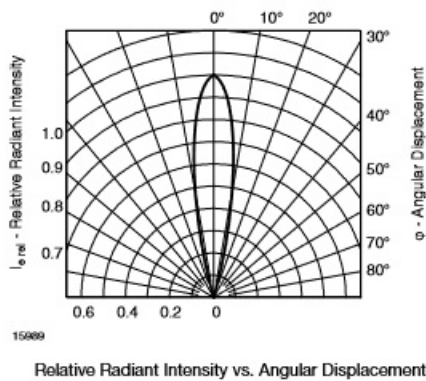

“Sources of incoherent light can be viewed safely because the light reaching the eye is only a small portion of the total output and the energy is spread over the entire retina.” (Source: http://www.ehss.vt.edu/Programs/OHIH/Laser/04_beam_hazards.htm)

The Infrared pulse is 940 nanometers. Battlefield Sports outdoor laser tag units emit invisible, harmless infrared light, just like the infrared used in many TV remote controls. Despite the name “laser tag” there are actually no lasers used. Therefore, the units are eye-safe, safety glasses are not required.

Infrared laser diodes and light-emitting diodes (also known as LEDs or IREDs) are widely used in displays and in TV remote control systems, and in toys.

These LEDs are basically small light bulbs or flashlights. Instead of shining visible light, they emit invisible infrared light. Unlike incandescent lamps which emit light over a board range of wavelengths, LEDs emit light over a narrow bandwidth.

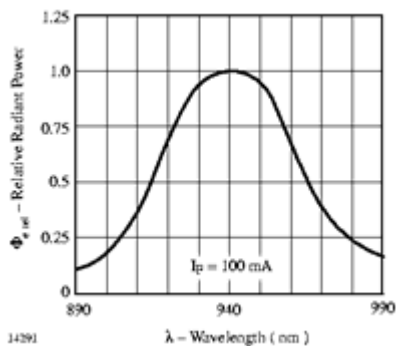

SATR Audio

The comprehensive SATR3 system integrates more than 11,000 sound effects.

The audio specifications are: 11025/22050/44100 Hz, 8/16 bit.

SATR Battery

The SATR system is powered by a rechargeable NiMH battery: 7.2v (4,000mAh) Although a lower-powered battery such as 3,000mAh would be sufficient for regular operations. Turn the unit on with the key. This equipment does not require CO2 capsules nor uses BB bullets to operate. Rather the unit is powered by a Nickel Metal Hydrate (NiMH) battery.

These batteries are not restricted as per special provision A199.

Compliance Testing

A selection of our laser tag portfolio has been subject to independent laboratory compliance testing.

Testing includes:

- FCC
- CE,
- WEEE,
- RoHS.

For a comprehensive list of reports refer to the web site.

<https://battlefieldsports.com/compliance-reports>

Warranty Terms

Battlefield Sports ("BFS") warrants that in respect of metal units (other than previously used guns), for a period of 24 months from the date of original purchase; and in respect of scopes and electronic parts, for a period of 6 months from the date of the purchase.

In each case the "Warranty period", the goods will be free from defects in material and workmanship under normal use and reasonable care (as determined in the sole opinion of BFS); fair wear and tear excepted. This warranty does not apply to infrared transmitters, sensor cables, fuses, switches and buttons used in goods as these are considered to be consumables. Furthermore, this warranty does not cover any goods which have been subject to misuse, abuse, neglect, accidental damage, excess heat or moisture or the use of incorrect voltage or current when charging or an alteration to the goods which affects the viability or performance of the goods ("excluded defects"). If the goods are or become faulty during the Warranty Period, BFS will repair or replace the goods (at its election) at no cost to you (other than freight and insurance charges which are your responsibility) provided you can satisfy BFS that the defect in the goods falls within the warranty set out above and is not an excluded defect. To make a claim in respect of the goods which you believe are defective, please contact BFS at:

6/2 Commercial Drive, Shailer Park, Queensland 4128 Australia

Phone: 61 (0) 7 3209 9555

Fax: 61 (0) 7 3209 8088

Email: support@battlefieldsports.com



You will need to advise BFS of the following information with your claim:

1. details of the product and a description of the defect;
2. evidence of purchase (date and place);
3. the date on which defect appeared or became evident and the circumstances of usage. BFS will advise you whether it is necessary to return the goods for assessment of the claim. If BFS, its agent or TechCo can diagnose and resolve the problem by phone or email, then it will do so. If it cannot, then BFS will indicate to you where to send the goods. In the case of inflatables, this may be to the factory in China of the manufacturer. If BFS determines the goods to be faulty and that the fault falls within the Warranty. We will decide whether to repair or replace the goods and advise you accordingly.

If BFS decides that the goods do not fall within the Warranty or the defect is an excluded defect. BFS will send you a quotation for repairs or replacement. If you do not accept the quotation, the goods will be returned to you at your cost. The benefits under this Warranty are in addition to other rights and remedies available to you under the law. However, except to the extent that the exclusion, restriction or modification of such rights and remedies is prohibited by the Australian Consumer Law or other legislation as the same may apply to the supply of these goods, the warranties expressed herein are in lieu and to the exclusion of, and you waive, all other warranties, rights and remedies whatsoever related to the goods, whether express or implied, statutory or otherwise. Our goods come with guarantees that cannot be excluded under the Australian Consumer Law. You are entitled to a replacement or refund for a major failure and for compensation for any other reasonably foreseeable loss or damage. You are also entitled to have the goods repaired or replaced if the goods fail to be of acceptable quality and the failure does not amount to a major failure.

Disclaimer

All product, product specifications and data are subject to change without notice to improve reliability, function or design, or otherwise. Battlefield Sports, its affiliates, agents, and employees, and all persons acting on its or their behalf disclaim any and all liability for any errors, inaccuracies or incompleteness contained in any datasheet or in any other disclosure relating to any product.

	WARNING: This is a commercial product. It is recommended for use by those 7 years of age or older. Read all instructions before using. The purchasers and user should confirm to all governing the purchase, use, and ownership of laser tag equipment and accessories.
	WARNING: Do not brandish or display these laser tag units in public – it may confuse people and may be a crime. Police and others may think it is a real firearm. Do not change the coloration and marketing to make it look more like a firearm. That is dangerous and may be crime.

We reserve the right to make color and design changes and technical improvements. No responsibility is accepted for printing errors or incorrect information.

© Battlefield Sports 2019

6/2 Commercial Drive, Shailer Park, Queensland 4128 Australia

Phone: 61 (0) 7 3209 9555

Fax: 61 (0) 7 3209 8088

Email: support@battlefieldsports.com

www.battlefieldsports.com